



PTZMoverIP Operators Guide
11/25/2024

Contents

Package Contents3

Figure 1: 24” PTZMoverIP with Floor Mounted Baseplate.....3

Figure 2 : PTZ Mover with Vertical Pipe-Grid Ceiling Mount Bracket4

Figure 3 : PTZ Mover with Uni-Strut Ceiling Mount Bracket4

Figure 4 : PTZ Camera Adapter Plate (bottom view).....5

Figure 6 : Optional Hand-Held Up/Down Remote5

System Setup.....5

Cabling Diagram.....8

Configuring the PTZMoverIP for PTZ Camera Controller operation8

Overview8

Web-Server Configuration9

Web-Server Screenshot, Status Tab9

Web-Server Screenshot, Ethernet Config Tab9

Web-Server Screenshot, Protocol Config Tab11

PresenterTek’s IP Controller App, Configuration Tab.....11

PresenterTek IP Controller App Screenshot.....12

PresenterTek’s IP Controller App, Control Tab13

Configure for Sony RM-IP500 controller.....15

Overview:.....15

Sony RM-IP500 LAN defaults.....15

PTZMoverIP with Sony Controller settings:.....15

Method 1: Auto -IP Step by Step instructions.....15

Method 2: Modifying PTZMoverIP to match an existing Camera in the Camera Table16

Operation.....16

<i>Configure for Sony's RM-IP10 PTZ Camera Controller</i>	17
Sony's RM-IP Setup application configuration:	17
Sony's RM-IP Setup Tool. Camera Tab and Camera Table Screenshots.....	18
<i>Configuration for PTZ Optics SuperJoy Controller:</i>	20
Using Sony VISCA Over IP protocol	20
VISCA Over IP	20
<i>Configure for PTZ Optics Windows Controller App</i>	21
<i>Configure for BirdDog's / Lumens/ Marshall PTZ Camera Controllers</i>	22
<i>Configure for Panasonic AW Camera Controllers</i>	22
Configure for direct control using VISCA Over IP commands directly	23
<i>Recommended Setup for VISCA Over IP commands directly</i>	23
<i>VISCA Command List</i>	24
VISCA Command Reply	24
<i>VISCA Inquiry Commands</i>	25
Stroke to Position Table	25
Inquiry Status Reply	25
Operation:	25
<i>Operation via PTZ Camera Controller</i>	25
Demo Mode	26
Firmware Upgrade Procedure	26

Package Contents

Quantity	Description
1	Stand Assembly
1	+24V Wall Power Supply
1	50 foot RJ45/Ethernet Cable
1	Floor Baseplate, Ceiling or Wall Mount bracket. For Ceiling mount: Either Horizontal or Vertical Pipe Grid, or Uni-strut. (with mounting hardware)
1	1" diameter convoluted tubing
1	PTZ Camera Plate Adapter Assembly with extra thumbscrew

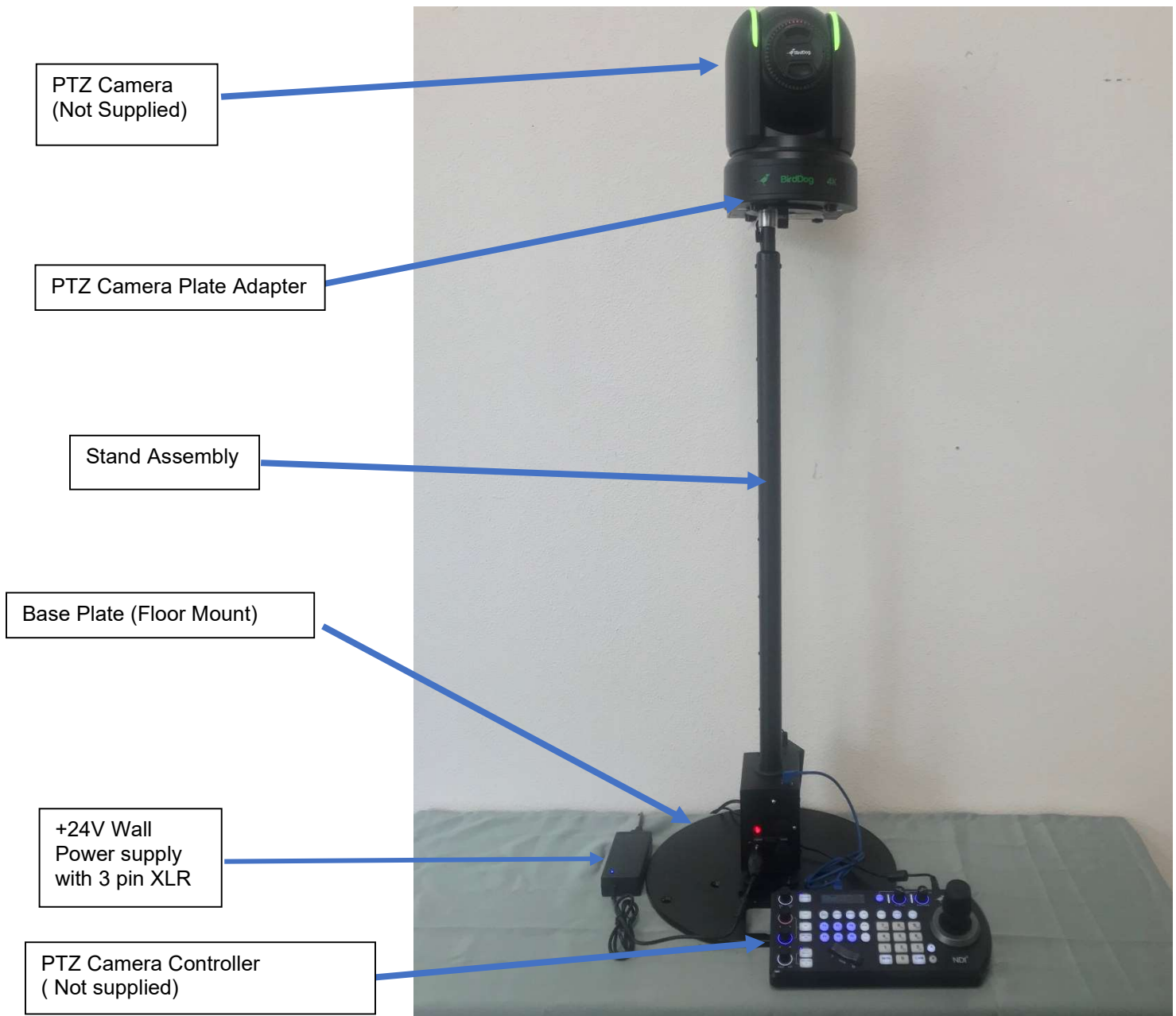

Figure 1: 24" PTZMoverIP with Floor Mounted Baseplate



Figure 2 : PTZ Mover with Vertical Pipe-Grid Ceiling Mount Bracket
(Horizontal Bracket not shown)

Align PTZ Mover to 5/16-18 threaded holes in plate. Attach using supplied thumbscrews (4 Places)



Attach PTZ Mover bracket securely to ceiling struts using these holes with supplied hardware

Figure 3 : PTZ Mover with Uni-Strut Ceiling Mount Bracket

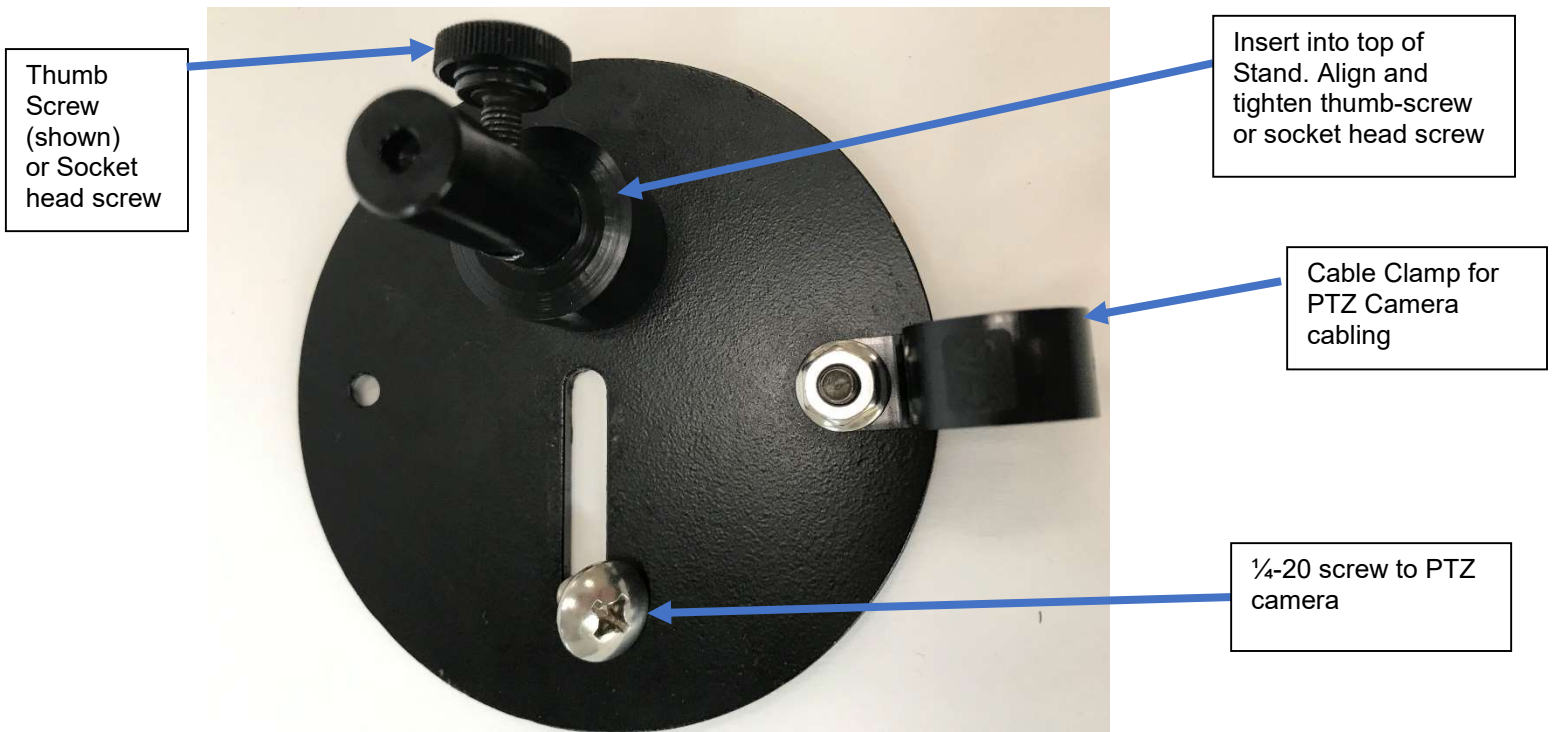

Figure 4 : PTZ Camera Adapter Plate (bottom view)



Figure 6 : Optional Hand-Held Up/Down Remote

System Setup

- 1) Remove the stand assembly and place it either on the baseplate or on the Ceiling Mount bracket. Align the stand's 4 thumbscrews to either the baseplate or ceiling mount threads and tighten the 4 thumbscrews
- 2) Unpack the PTZ Camera Adapter plate and place inside the top of the stand. Align and tighten using either the thumb screw (shown) or black socket head screw.



- 3) Use the ¼-20 screw to attach the PTZ Camera to the adapter plate
- 4) If desired, use the included convoluted tubing along with the attached cable clamps on the PTZ Adapter plate and Stand base to route the cabling from the PTZ camera
- 5) Cable the Stand assembly, Wall Power supply and Remote Control as described below



- 6) If using a PTZ Camera Controller, or other IP controller, Plug the RJ45/Ethernet Cable into the the IP RJ45 port .

Note:

A 50 foot cable is included, if a longer cable is required, any Cat 5 or higher Ethernet cable can also be used.

- 7) Plug the RJ45/Ethernet Cable into the PTZ Camera Controller , or IP controller (not supplied)
- 8) If using the Optional Hand-Held Remote, Plug int "Remote Control" Input
- 9) Note; Power Over Ethernet (POE) is not supported. The +24V power supply must be used

Note:

On Power up, the PTZ Mover will automatically move to the home position.

If the shaft is extended, it will retract to lowest home position.

If already at the home position when power is applied, it will move up 3/8" and then back down

Cabling Diagram

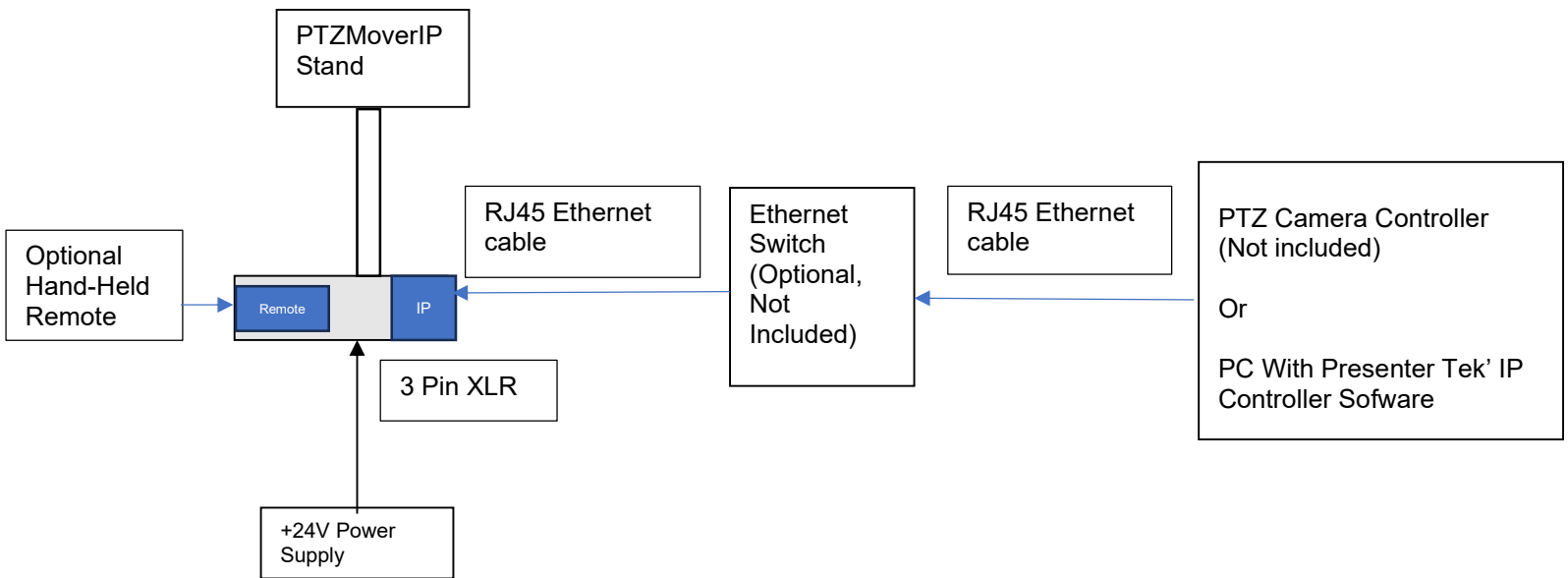

Configuring the PTZMoverIP for PTZ Camera Controller operation

Overview

The PTZMoverIP supports the various VISCA over IP protocols. This permits it to be controlled by almost all professional-grade PTZ camera controllers, including Sony, PTZ Optics, Skaarhoj, BirdDog, Marshal, Bolin, Lumens, Creston and RocoSoft.

The PTZMover must be configured correctly to operate with these various PTZ Camera Controllers. IP settings, IP address, port numbers, transport protocols (UDP or TCP) and the various VISCA or AW protocols can be configured.

There are two methods for configuring the PTZMoverIP:

1. Use the built in **Web-Server**. The default IP address is 192.168.0.100. Type this address into any Web browser (Firefox, Google Chrome ...)

Note:

To use the Web-Server, the LAN of the PC must be configured to be on the same network as the PTZ Mover:

Also, the Web-Server cannot configure the specific type of Controller Protocol, Sony VISCA, VISCA, VISCA Serial The PresenterTek's IP Controller app must be used for this

Default IP	192.168.0.100
User Name	admin
Password	admin

2. Download PresenterTek's IP Controller app. Please contact PresenterTek for instructions on where to download this app

Note:

To use all the features of the PresenterTek's IP Controller app, namely the Controller Protocol and Firmware Version, the LAN of the PC must be configured to be on the same network as the PTZMoverIP

Web-Server Configuration

- a) Power up PTZMoverIP unit: a RJ45 ethernet cable must be connected to PC and the PTZMoverIP, via either direct connection or an ethernet switch.
- b) Enter PTZ Mover's IP address into any web browser:

Default IP 192.168.0.100

Once the Login page appears, input the following:

User name: admin
Password: admin

After the correct login credentials are inputted, the following should appear:

Web-Server Screenshot, Status Tab

The screenshot shows a web browser window displaying the PresenterTek IP Device Webpage. The page title is "PresenterTek IP Device Webpage Rev. 2.0". The main header is blue and contains the PresenterTek logo on the left, the text "IP Device Web Interface" in the center, and the PresenterTek logo on the right. Below the header is a navigation menu with the following items: "Current Status", "Ethernet Config", "Protocol Config", and "Reboot". The "Current Status" tab is selected, showing a table with the following data:

parameter
Device Name: PTZMoverIP
Current IP Address: 192.168.0.100
MAC Address: d4-ad-20-7e-d0-22

On the right side of the page, there is a "Help" section with the following content:

- **Current IP Address:** Device's IP addr
- **MAC Address:** Machine Address of Device



At the bottom of the page, there is a footer with the text "Copyright © 2024 · PresenterTek" on the left and "website: www.presentertek.com" on the right.

To change the modules IP address, Subnet Mask, Gateway or DNS Server, go to the Ethernet Config Tab. The following will appear. After changes are made, click "Save" and then "Restart Module"

Web-Server Screenshot, Ethernet Config Tab

x | +

PresenterTek IP Device Webpage Rev. 2.0

IP Device Web Interface

Current Status

Ethernet Config

Protocol Config

Reboot

parameter:

IP type:	<input style="width: 100%;" type="text" value="Static IP"/>			
IP Addr:	<input type="text" value="192"/>	<input type="text" value="168"/>	<input type="text" value="0"/>	<input type="text" value="100"/>
Subnet Mask:	<input type="text" value="255"/>	<input type="text" value="255"/>	<input type="text" value="255"/>	<input type="text" value="0"/>
Gateway:	<input type="text" value="192"/>	<input type="text" value="168"/>	<input type="text" value="0"/>	<input type="text" value="1"/>
DNS Server IP:	<input type="text" value="0"/>	<input type="text" value="0"/>	<input type="text" value="0"/>	<input type="text" value="0"/>

Help

- **IP type:**
Static IP only
- **IP Addr:**
Devices's IP Addr
- **Subnet Mask:**
Usually
255.255.255.0
- **Gateway:**
Usually Router's IP
address
- **DNS Server IP:**
DNS IP Addr

Copyright © 2024 · PresenterTek
website: www.presentertek.com

To change the PTZMoverIP's port number, Protocol Mode, PTZ camera controller's port number or PTZ camera controller's IP address, click to the Protocol Config tab. The following screenshot will appear, and after all changes are made, click "Save" and then "Restart Module". Restarting the module can take up to 15 seconds.

After the "IOT Device Restarted" page appears, cycle power on the PTZMoverIP stand.

Web-Server Screenshot, Protocol Config Tab

The screenshot displays the PresenterTek IP Device Web Interface. The page title is "PresenterTek IP Device Webpage Rev. 2.0". The interface includes a navigation menu on the left with options: "Current Status", "Ethernet Config", "Protocol Config" (highlighted in orange), and "Reboot". The main content area is titled "parameter" and contains the following configuration fields:

- PresenterTek's Device Port Number: (0-65535)
- Protocol Mode: (dropdown menu)
- PTZ Controller Port Number (Client Only):
- PTZ Controller IP: [192.168.0.50]

At the bottom of the configuration area, there are "Save" and "Cancel" buttons. The footer of the page contains "Copyright © 2024 · PresenterTek" and the website URL "website:www.presentertek.com".

PresenterTek's IP Controller App, Configuration Tab

- Download and install the PresenterTek IP Controller app. Contact PresenterTek support for further instructions
- Power up PTZMoverIP unit. An ethernet cable must be connected to Windows PC, (MAC not currently supported) and the PTZMoverIP, either direct connect or via an ethernet switch/hub
- Launch app
- Select the "Configuration" Tab

PresenterTek IP Controller App Screenshot

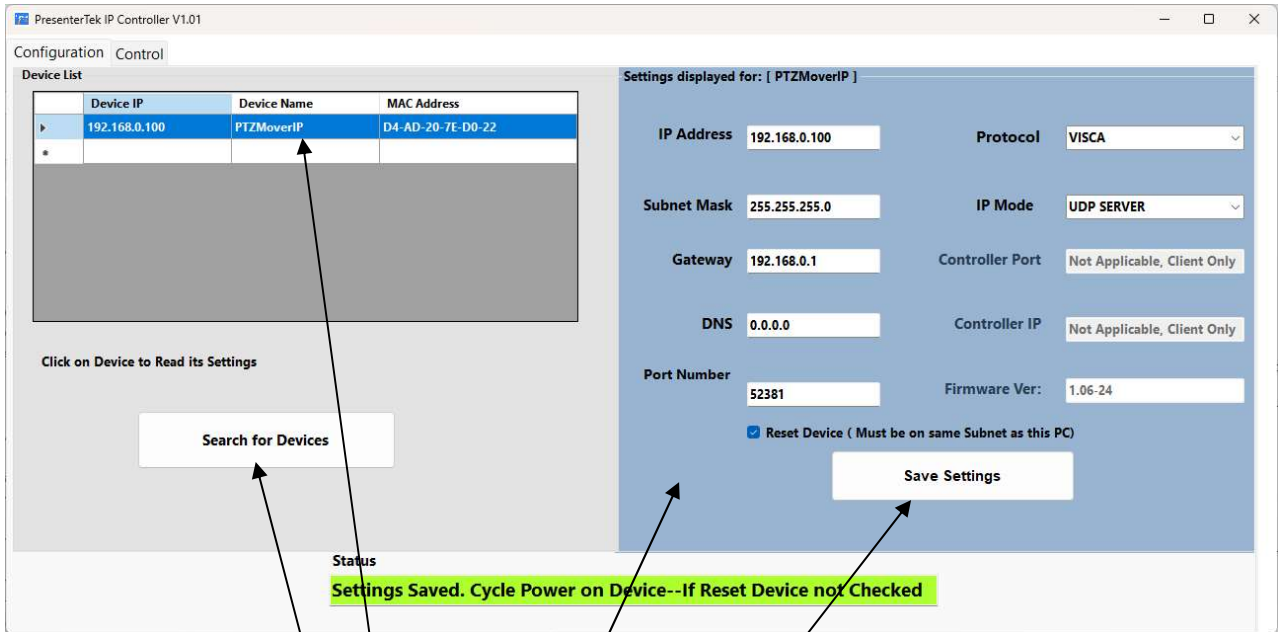

- e. Click on "Search for Devices"
- f. Select desired PTZMoverIP to configure from list
- g. Input desired changes on right hand side.
- h. When finished, click "Save Settings". The module will automatically reboot if the "Reset Device" is checked. This can take up to 10 seconds.
- i. To verify correct settings, after PTZMoverIP has rebooted, click "Search For Devices" and then select desired unit

Notes:

- a. If the PC is not configured to be on the same LAN as the PTZMoverIP, the "Protocol" and the "Firmware Ver" will not be readable. A Yellow "Connection Error" message will appear in those boxes.
With Windows 10 Settings -> Network & internet->LAN-Properties
- b. If more than one instance of the app is running at the same time, unpredictable results may occur

PresenterTek's IP Controller App, Control Tab

In order to test, or use in lieu of an external PTZ Camera Controller, the PTZMoverIP for proper operation:

- a. Select the "Control" Tab

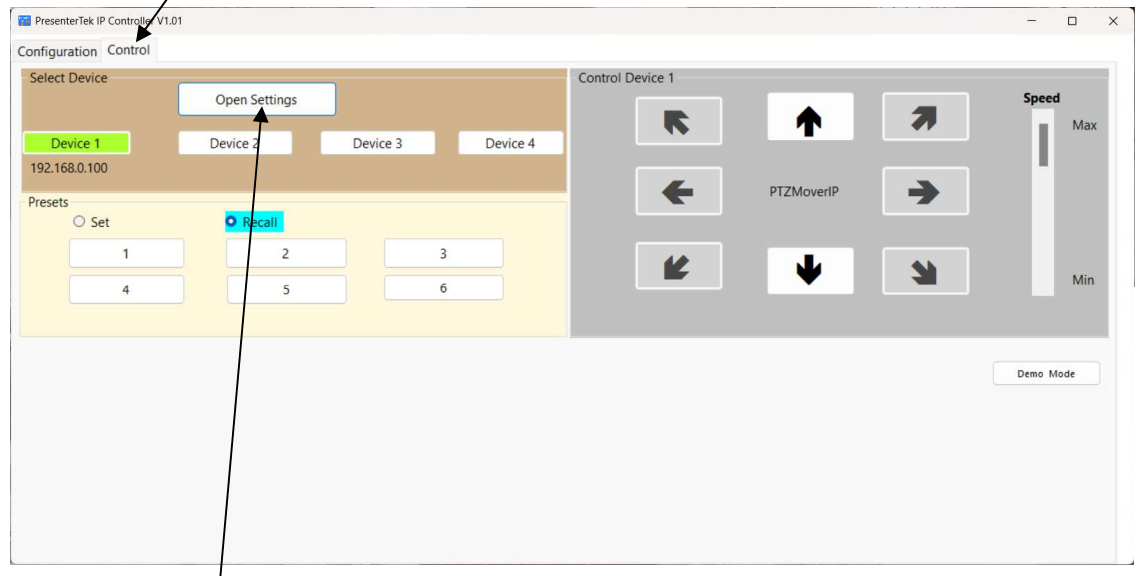

- b. Click on the "Open Settings" button

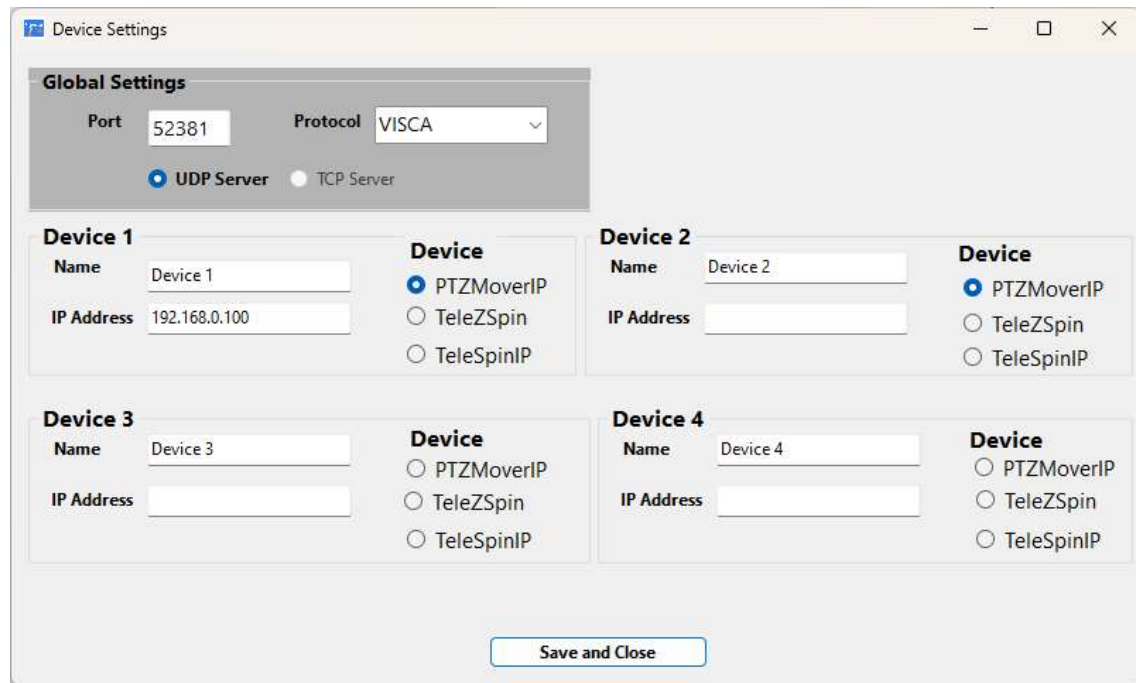

- c. Enter in the following as configured in the "Configuration" tab:
- Port (52381 is factory default)
 - Protocol (Sony VISCA, VISCA Serial)
 - IP address (192.168.0.100 factory default)
 - Device Type(PTZMoverIP, TeleZSpin or TeleSpinIP)
 - Reenter "Device Name" if desired
 - Click "Save and Close"
 - On the "Control" Form,

- i. Arrow buttons will move the PTZMoverIP in the indicated direction
- ii. Up to 4 separate PTZMoverIP's can be controlled by selecting the correct "Device"
- iii. Speed can be controlled by using the "Speed" slider
- iv. Up to 6 Preset positions can be "Set" (Stored) and Recalled

Note:

The PC must be configured to be on the same LAN as the PTZMoverIP.

Setting the PC to the same PTZMoverIP's Subnet Mask (default = 255.255.255.0), Gateway (default = 192.168.0.1) and some other unique IP address, 192.168.0.50 for example, will work

Configure for Sony RM-IP500 controller

Overview:

The Sony RM-IP500 uses the Sony VISCA protocol, UDP Server at port 52381. The controller uses an Auto-IP setup to configure all network devices connected. This routine will automatically assign the IP address, Subnet mask and Gateway address based on MAC address of each device.

Either the PresenterTek's IP Controller app or the built in HTML web server can be used to configure the PTZMoverIP

Sony RM-IP500 LAN defaults

Below are Sony's factory default settings. Go to Config->LAN to get the actual settings:

Parameter	Value
IP Address (IP)	192.168.0.10
Subnet Mask (SM)	255.255.255.0
Gateway (GW)	192.168.0.1

PTZMoverIP with Sony Controller settings:

Parameter	Value
IP Address	192.168.0.100(default)
Subnet Mask	255.255.255.0
Gateway	192.168.0.1
Protocol Mode	UDP Server
Controller Protocol:	Sony VISCA
Port	52381

There are two methods to configure the PTZMoverIP to the Sony Controller

- 1) **Method 1:** Auto-IP Configuration
- 2) **Method 2:** Modify the PTZMoverIP LAN parameters to match an existing camera in the RM-IP500's Camera Table.

Method 1: Auto -IP Step by Step instructions

Overview:

To use the Auto IP setup, the PTZMoverIP port must be configured to 52380. For normal operation, port 52381 must be used. The PTZMoverIP must also be on the same subnet as the Sony RM-IP500.

Setting up the PTZMoverIP is like setting up any Sony camera. The main difference is the PTZMoverIP's port must be manually changed to 52380 for Auto IP Setup. Then, must be manually changed back to 52381. It is important to **reset or cycle power on the** PTZMoverIP after changing the port number

- 1) Power up PTZMoverIP stand. Cable as described above. Using a ethernet hub/switch with both the RM-IP500 and host computer connected to camera(s) prevents from swapping cables.
- 2) Using either the PTZMoverIP built in HTML server or the PresenterTek's IP Controller app.
 - a. Change the PTZMoverIP Port to **52380**.
 - b. The PTZMoverIP must be reset after changing the Port number. This can be done by either:
 - i. Cycle the power on the PTZMoverIP

- ii. Make sure the “Reset Device” checkbox in the IP controller app is selected
- 3) On the RM-IP500. Auto set the LAN parameters
 - a. Auto IP Setup -> Setup IP->**EXEC** -> Press “Value” knob. “Wait a Few Seconds” will appear.

If “No Cameras Found” message appears, try cycling the power on the PTZMoverIP and try again. Verify that the PTZMoverIP port is 52380
 - b. Confirm Execution -> Confirm -> **YES**, then press “Value” button. “Wait a few Seconds” and then “Complete Done” should appear.
 - c. Use “Cancel” button to back out of menu
- 4) Assigning the PTZMoverIP to the desired Camera Number/Group on the Sony RM-IP500
 - c. Auto IP Setup->Assign CAM
 - d. Select desired Group Num and Camera Num for the PTZMoverIP
 - e. CAM->**EXEC**, “Wait a Few Seconds” will appear
 - f. Scroll down to “KEEP IP” Select “**EXEC**”, then press “Value” knob
 - g. Confirm -> Yes. Press “Value” knob. Then “Complete Done” should appear on display
 - h. Hit CANCEL button to exit menu
- 5) To verify, Check the Camera Table on the RM-IP500, “Auto-IP Setup-> Camera Table”. The PTZMoverIP should show up. You can verify by checking the MAC address
- 6) Open PresenterTek’s IP Configuration app, or the built in HTML web server, to change port to **52381** on the PTZMoverIP
- 7) Reset or cycle power on the PTZMoverIP

Method 2: Modifying PTZMoverIP to match an existing Camera in the Camera Table

- 1) If a camera does not already exist in the Camera Table, attach a Sony Camera, and run “Auto IP Setup->Setup IP”
- 2) The selected camera, remove from the LAN by either powering off or removing the Ethernet cable
- 3) Examine the Camera Table (“Auto IP Setup ->Setup IP-> Camera Table”)
- 4) Select the camera number you wish the PTZMoverIP to assign, note its IP address
- 5) Using either the PTZMoverIP Built in Web-server, or the PresenterTek’s IP config app, described above, configure the PTZMoverIP as follows.

Parameter	Value	How to Find using Sony Controller
IP Address: (IP:)	Match value in Camera Table	“Auto IP Setup ->Setup IP-> Camera Table”
Subnet Mask: (SM:	Match Sony controller’s	“Config ->LAN”
Gateway (GW:)	Match Sony controller’s	“Config ->LAN”
Port Number	52381	
Protocol Mode	UDP Server	

- 6) To put the Sony PTZ Camera back in the table, connect the camera and use the “Auto IP Setup -> Setup IP”

Operation

- The following controls are active with the RM-IP500
- a. Correct Camera Number/Group that was assigned must be selected
 - b. Joystick-- Up/Down/Pan Left/Pan Right
 - c. Speed knob
 - d. Storing, Recall and moving to Preset positions.
 - e. P/T RST – Re-home both Axes

Note: With the Joystick at max speed (max deflection), there is some run on after the joystick is released. Lowering the Speed will fix this issue.

Configure for Sony's RM-IP10 PTZ Camera Controller

Sony's RM-IP Setup application configuration:

- a) Power up PTZMoverIP stand. An ethernet cable must be connected to PC and the PTZMoverIP, either directly connected or via an ethernet switch.
- b) The PTZMoverIP Protocol Mode must be UDP Server at Port 52380
- c) **When the port number is changed, the power must be cycled on the PTZMoverIP unit.**

Web Server	
Ethernet Config Tab	
IP Addr:	N/A
Subnet Mask:	Configure for LAN
Gateway	Configure for LAN
DNS Server IP:	N/A
Protocol Config Tab	
PresenterTek's Device Port Number	52380
PTZ Port Controller Number	N/A
Protocol Mode	UDP Server
PTZ Controller IP:	N/A
PresenterTek's IP Controller App	
IP Address	N/A
Subnet Mask	Configure for LAN
Gateway	Configure for LAN
DNS	N/A
Port Number	52380
IP Mode	UDP Server
Protocol	Sony VISCA
Controller Port	N/A
Controller IP	N/A

- d) Launch RM-IP app
- e) "TSpin" should appear after approximately 10 seconds on the camera tab. If it does not appear, click "Refresh" button, or go to the Controller tab and back to the Camera Tab.

Sony's RM-IP Setup Tool. Camera Tab and Camera Table Screenshots

The screenshot shows the 'Camera' tab of the RM-IP Setup Tool. The 'Camera List' table contains the following data:

<input type="checkbox"/>	Name	MAC address	IP address	Subnet mask	Gateway address	Vers...	Message
<input type="checkbox"/>	TSpin	F4-70-0C-6A-C1-14	192.168.0.100	255.255.255.0	0.0.0.0	2.10	Configuration is protected (read only).

Buttons at the bottom right: Refresh, IP assign, Apply.

Status bar: Camera:1 Controller:1

The screenshot shows the 'Camera Table' tab of the RM-IP Setup Tool. The configuration is as follows:

- Controle: CTL1 (192.168.0.10)
- MAC address: 94-DB-56-25-33-BF
- Filter: Unused, Name, IP address
- IP address input: 192 . 168 . 0 . 1 - 213

The 'Camera Table' contains the following data:

<input type="checkbox"/>	Group - No	Camera Name	MAC address	IP address	Message
<input type="checkbox"/>	Group1-1	TSpin	F4-70-0C-6A-C1-14	192.168.0.100	
<input type="checkbox"/>	Group1-2				
<input type="checkbox"/>	Group1-3				
<input type="checkbox"/>	Group1-4				
<input type="checkbox"/>	Group1-5				
<input type="checkbox"/>	Group1-6				
<input type="checkbox"/>	Group1-7				
<input type="checkbox"/>	Group2-1				
<input type="checkbox"/>	Group2-2				
<input type="checkbox"/>	Group2-3				
<input type="checkbox"/>	Group2-4				
<input type="checkbox"/>	Group2-5				
<input type="checkbox"/>	Group2-6				
<input type="checkbox"/>	Group2-7				
<input type="checkbox"/>	Group3-1				

Buttons at the bottom right: Refresh, Auto assign, Copy, Clear, Apply.

Status bar: Camera:1 Controller:1 Setup was succeeded.

After assigning the PTZMoverIP (TSpin) to the Camera Table, ensure the PTZMoverIP is returned to the standard Sony VISCA over IP settings (UDP Server, Port = 52381) as described above prior to using the PTZ controller.

Note: When the port number for the PTZMoverIP is changed back to 52381, **the power must be cycled on the PTZMoverIP unit** for it to take effect

Configuration for PTZ Optics SuperJoy Controller:

The PTZ Optics SuperJoy can either be configured for Sony VISCA over IP or VISCA Over IP
 Note: SuperJoy Default IP is 192.168.100.89

Using Sony VISCA Over IP protocol

Web Server		
Ethernet Config Tab	IP Addr:	Must match PTZ controller setting
	Subnet Mask:	Configure for LAN
	Gateway	Configure for LAN
	DNS Server IP:	N/A
	Protocol Config Tab	
PresenterTek's Device Port Number	52381(Default, but can be changed in the PTZ controller)	
PTZ Controller Port Number	N/A	
Protocol Mode	UDP Server	
PTZ Controller IP:	N/A	
PresenterTek's Controller App		
Ethernet Config Tab	IP Address	Must match controller setting for the PTZMoverIP
	Subnet Mask	Configure for LAN
	Gateway	Configure for LAN
	DNS	N/A
	Port Number	52381(Default, but can be changed in the PTZ controller)
	IP Mode	UDP Server
	Protocol	Sony VISCA
	Controller Port	N/A
	Controller IP	N/A

VISCA Over IP

PTZ Mover must be set to VISCA over IP protocol using the PTZ Mover Config App. In addition, UDP Server and Port 1259 must be selected.

Web Server		
Ethernet Config Tab	IP Addr:	Must match controller's setting for the PTZMoverIP.
	Subnet Mask:	Configure for LAN
	Gateway	Configure for LAN
	DNS Server IP:	N/A
	Protocol Config Tab	
PresenterTek's Device Port Number	1259	
PTZ Port Controller Number	N/A	
Protocol Mode	UDP Server	
PTZ Controller IP:	N/A	

PresenterTek's IP Controller App		
	IP Address	Must match controller's setting for the PTZMoverIP
	Subnet Mask	Configure for LAN
	Gateway	Configure for LAN
	DNS	N/A
	Port Number	1259
	IP Mode	UDP Server
	Protocol	VISCA
	Controller Port	N/A
	Controller IP	N/A

Configure for PTZ Optics Windows Controller App

The Windows PTZOptics controller app uses TCP Server at port 5678.

PTZMoverIP must be set to VISCA protocol using the PresenterTek's IP Controller App. In addition, TCP Server and Port 5678 must be selected.

Web Server		
Ethernet Config Tab		
	IP Addr:	Must match PTZ controller's setting
	Subnet Mask:	Configure for LAN
	Gateway	Configure for LAN
	DNS Server IP:	N/A
Protocol Config Tab		
	PresenterTek's Device Port Number	5678
	PTZ Controller Port Number	N/A
	Protocol Mode	TCP Server
	PTZ Controller IP:	N/A
PresenterTek's IP Controller App		
	IP Address	Must match PTZ Controller's setting
	Subnet Mask	Configure for LAN
	Gateway	Configure for LAN
	DNS	N/A
	Port Number	5678
	IP Mode	TCP Server
	Protocol	VISCA
	Controller Port	N/A
	Controller IP	N/A

Configure for BirdDog's / Lumens/ Marshall PTZ Camera Controllers

Note: for reliable operation. Camera settings on the controller must be set to Camera Type = General

Web Server		
Ethernet Config Tab	IP Addr:	Must controller's setting
	Subnet Mask:	Configure for LAN
	Gateway	Configure for LAN
	DNS Server IP:	N/A
Protocol Config Tab	PresenterTek's Device Port Number	52381
	PTZ Controller Port Number	N/A
	Protocol Mode	UDP Server
	PTZ Controller IP:	N/A
PresenterTek's IP Controller App		
	IP Address	Must match PTZ Controller's setting
	Subnet Mask	Configure for LAN
	Gateway	Configure for LAN
	DNS	N/A
	Port Number	52381
	IP Mode	UDP Server
	Protocol	VISCA = No Header Sony VISCA = Header on Note: BirdDog controllers must use: BirdDog with Header or BirdDog No Header. Must match controller setting
	Controller Port	N/A
	Controller IP	N/A

Configure for Panasonic AW Camera Controllers

Web Server		
Ethernet Config Tab	IP Addr:	Must controller's setting
	Subnet Mask:	Configure for LAN
	Gateway	Configure for LAN
	DNS Server IP:	N/A
Protocol Config Tab	PresenterTek's Device Port Number	80
	PTZ Controller Port Number	N/A
	Protocol Mode	TCP Server
	PTZ Controller IP:	N/A
PresenterTek's IP Controller App		
	IP Address	Must match PTZ Controller's setting
	Subnet Mask	Configure for LAN

	Gateway	Configure for LAN
	DNS	N/A
	Port Number	80
	IP Mode	TCP Server
	Protocol	Panasonic AW
	Controller Port	N/A
	Controller IP	N/A

Configure for direct control using VISCA Over IP commands directly

This mode is typically used for Creston Controllers. Recommended setup is for UDP Server using VISCA Protocol as shown below

Recommended Setup for VISCA Over IP commands directly

Web Server		
Ethernet Config Tab		
	IP Addr:	Configure for LAN
	Subnet Mask:	Configure for LAN
	Gateway	Configure for LAN
	DNS Server IP:	N/A
Protocol Config Tab		
	PTZ Mover Port Number	Configure for LAN
	PTZ Port Controller Number	N/A
	Protocol Mode	UDP Server (preferred, but TCP/IP Server can be used)
	PTZ Controller IP:	N/A
PresenterTek's IP Controller App		
	IP Address	Configure for LAN
	Subnet Mask	Configure for LAN
	Gateway	Configure for LAN
	DNS	Configure for LAN
	Port Number	Configure for LAN
	IP Mode	UDP Server (preferred, but TCP/IP Server can be used)
	Controller Protocol	VISCA
	Controller Port	N/A
	Controller IP	N/A

VISCA Command List

The VISCA command subset listed below are relevant for the PTZMoverIP.

Command Set	Command	VISCA Command Packet (Hex)	Comment
Z Axis Move Up/Down	Up	81 01 06 01 01 vv 03 01 FF	Move Up until "Stop" command, or at end of stroke, is issued <vv> = Speed, 01 =slow, 18 = fast
	Down	81 01 06 01 01 vv 03 02 FF	Move Down until "Stop" command, or at end of stroke, is issued <vv> = Speed, 01 =slow, 18 = fast
	Stop	81 01 06 01 01 01 03 03 FF	
	Absolute Position	81 01 06 02 vv 00 00 00 00 00 00 zz zz zz zz FF	<vv> = Speed, 01 =slow, 18 = fast <zz zz zz zz> = absolute position in bytes (see table below for conversions to linear distance) Note: <zz> args are different from VISCA spec
	Relative Position	81 01 06 03 vv 00 00 00 00 00 00 zz zz zz zz FF	<vv> = Speed, 01 =slow, 18 = fast <zz zz zz zz > = Relative position in bytes (see table below for conversions to linear distance) Note: <zz> args are modified from VISCA spec.
	Home	81 01 06 04 FF	Move to home or zero position
	Reset	81 01 06 05 FF	Home to zero position using homing routine
Preset	Set	81 01 04 3f 01 pp FF	<pp> = Preset number 00 -127
	Recall	81 01 04 3f 02 pp FF	<pp> = Preset number 00 -127
	Reset	81 01 04 3f 00 pp FF	Set Preset to position 0 <pp> = Preset number 00 -127

VISCA Command Reply

For each of the commands issued above, the following replies will be sent

Reply type	Reply Message (Hex)	Comment
ACK	90 41 FF	Command accepted
Completion	90 51 FF	Command completed
Syntax Error	90 60 02 FF	Command not accepted, due to syntax error
Command Not Executable	90 61 41 FF	Not able to accept command, possibly due to < arg> out of range

Note; Both the ACK and Completion are sent in the same packet. Use the Inquiry Status command to determine when the actual motion has completed

VISCA Inquiry Commands

Command	Inquiry Packet(Hex)	Reply Packet(Hex)	Comments
Position	81 09 06 12 FF	90 50 00 00 00 00 00 pp pp pp pp FF	<pp> MSB first <pp> LSB last Position in bytes, see "Stroke to position" Table below
Status	81 09 06 10 FF	90 50 pp pp 00 00 FF	See "Inquiry Status Reply" Table below
Invalid Command— Syntax Error		90 60 02 FF	Syntax error

Stroke to Position Table

Stroke in Inches	Count per distance (Counts/inch)	Full stroke
6	1,597.5 counts/inch or	(decimal) 9,585 = (hex) 002571
12		(decimal) 19,170 = (hex) 004AE2
18	0.0006259 inch/count	(decimal) 28,755 = (hex) 007053
24		(decimal) 38,340 = (hex) 0095C4

Home Position is always <00><00><00><00>.

For Relative position command, if the Most Significant Bit is a 1, it is considered a negative value;

For example:

<80><00><00><01> will move Down (relative to floor mount) 1 step.

Whereas:

<00><00><00><01> will move Up (relative to floor mount) 1 step

Inquiry Status Reply

Most Significant byte (pp)	Least Significant byte (pp) x = don't care	Status
x x x x x x x x	1 x x x x x x x	Z axis Idle
x x x x 0 x x x	x x x x x 1 x x	Z axis moving
x x x x x 1 x x	x x x x x x x x	Initialization Complete
x x x x 1 x x x	x x x x x x x x	Initialization failed

Operation:

Operation via PTZ Camera Controller

Typically, the PTZ Mover unique IP address will also be assigned to a unique Camera number. Use the Up/Down on the Joy Stick for the Z axis movement. Preset positions, and tilt (Z-axis) speeds are also configurable using the PTZ Controller.

Note: The PTZ Camera Controller will not operate the PTZMoverIP has initialized the axis,

Note: On power up, the PTZMoverIP will automatically move to the home position. If the stand is extended, it will move towards the retracted position. If already at the home position, it will move down about ¼" and then back to the home position

Demo Mode

If the PTZ Camera Controller has a Backlight button, select the current PTZMoverIP. The Backlight button will toggle a demo mode operation.

Firmware Upgrade Procedure

The firmware can be upgraded using a Windows PC app. Please contact customer support for the app and the necessary upgrade files

1. Install PresenterTek's Bootloader app by double clicking Setup.exe and following the instructions
2. Install PresenterTek's PresenterTek's IP Controller app by double clicking Setup.exe and following the instructions. This is not necessary if you already know the PTZ Mover's IP address and Subnet mask
3. Connect an ethernet cable from the PC to the PTZ Mover.

Note:

Disconnect any PTZ Camera controller, or any other device that may attempt to communicate, including any Ethernet Hubs or Switches, with the PTZMoverIP.

A direct connect from the PC to the PTZMoverIP is strongly recommended. Remove any Ethernet Hub or Switches

No other devices can communicate with the PTZMoverIP during the firmware upgrade process. Disconnect any PTZ Camera controller.

4. Ensure that the PC is on the same local network as the PTZ Mover. With Windows 10 Settings -> Network & internet->LAN-Properties

Using the PresenterTek's IP Configuration app.
PTZ Mover

IP = 192.168.0.100

Subnet mask = 255.255.255.0

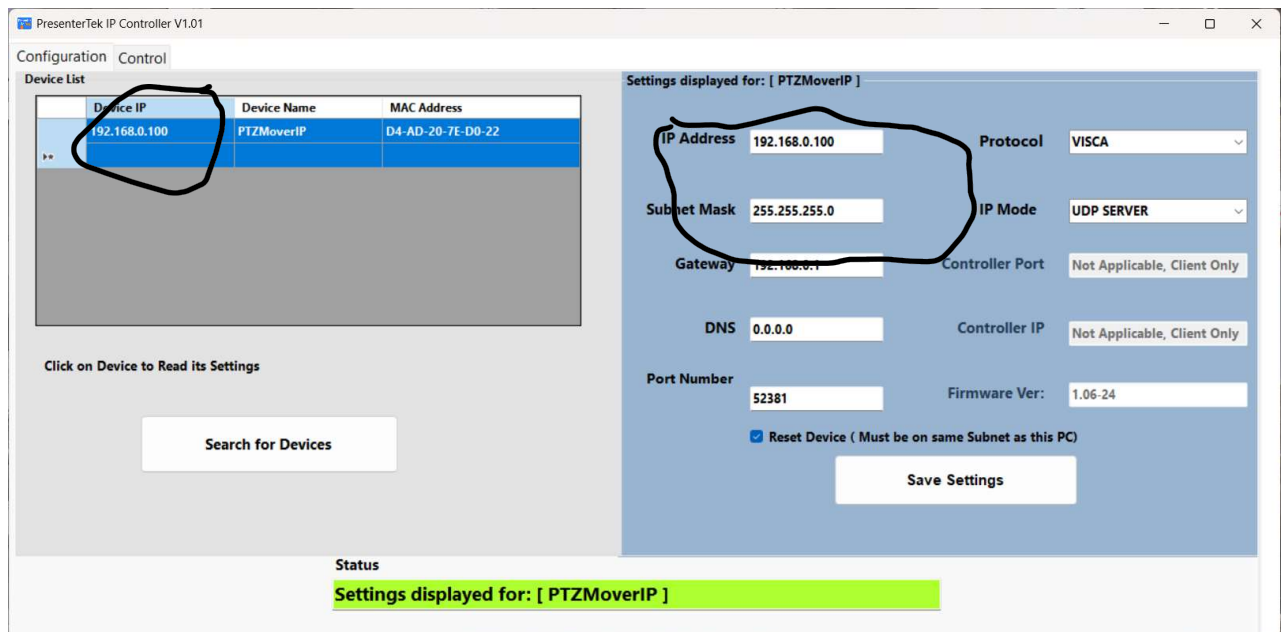

To ensure the host PC is configured for the same LAN:
Windows 10 Settings -> Network & internet->LAN-Properties

PC

IP = 192.168.0.50
Subnet mask = 255.255.255.0

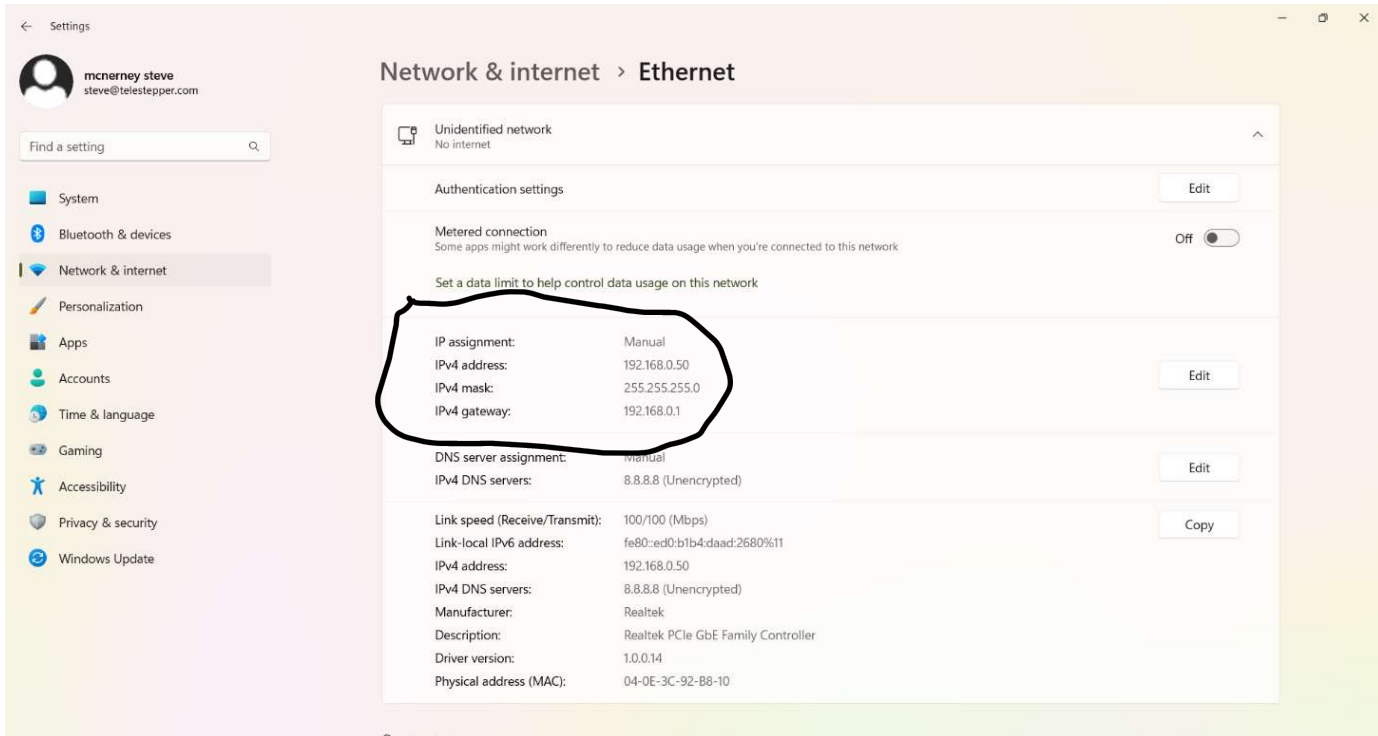

Note how the PC's IP address and Subnet mask are on the same LAN as the PTZMoverIP. The IP assignment must be set to Manual (or Static IP). Not DHCP

5. Power up PTZMoverIP and wait until initialized. That is, the Z axis is idle
6. Launch Bootloader App
7. Ensure that Product Select is set correctly
8. Click "Get Firmware Version" If a Firmware Version is displayed. The PC is correctly connected to the PTZMoverIP

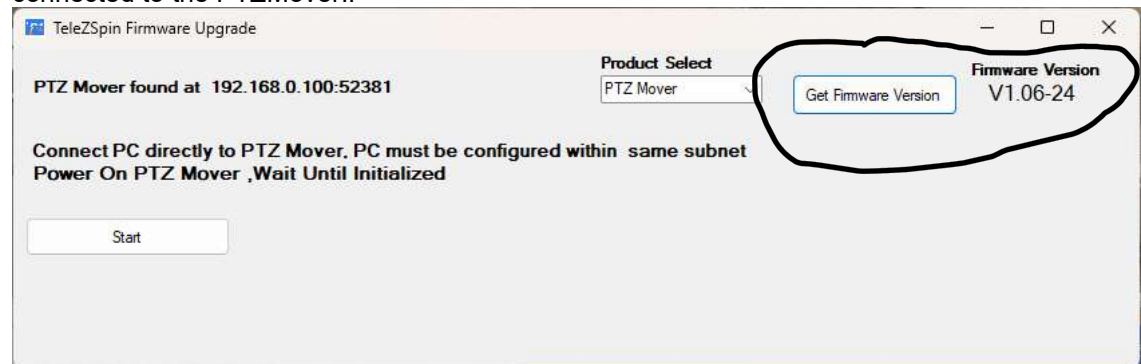

9. Click "Start" the following should appear:

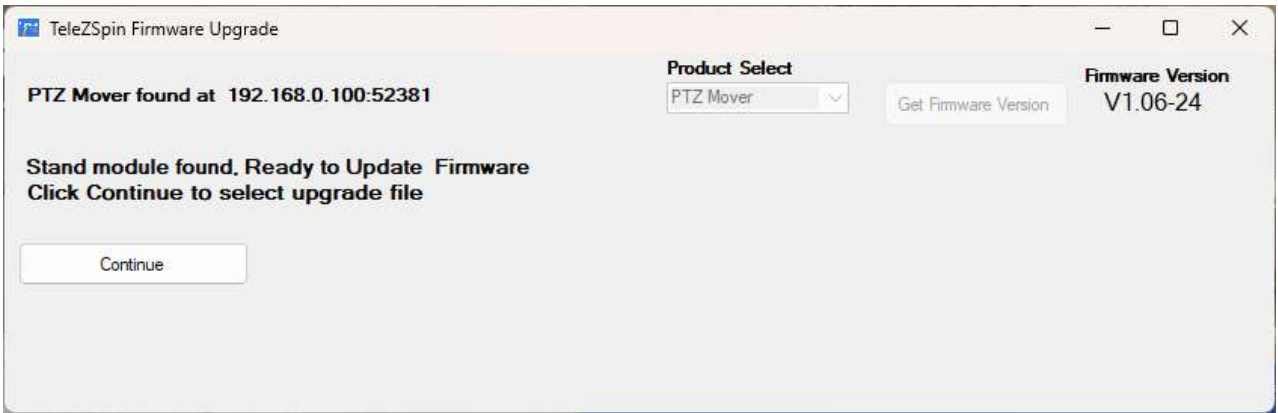

10. Click “Continue” and select correct update file, upgrade file will be supplied by PresenterTek. The firmware upgrade file name will be in the format “PTZMoverIP_UpdateVXXX.hex”

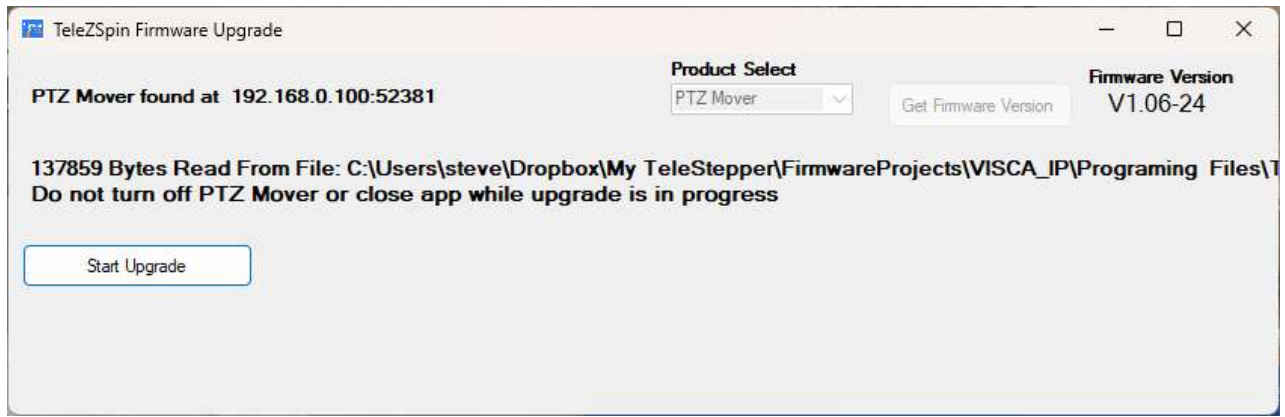

11. Click “Start Upgrade”
12. Wait until Firmware upgrade is complete

Warning!

Do not interrupt the Firmware upgrade process by closing the app, removing the ethernet cable or powering off the PTZMoverIP. This may corrupt the firmware and require an corrupted firmware upgrade procedure. Please contact technical support if this occurs

13. If all goes well, the following should appear:

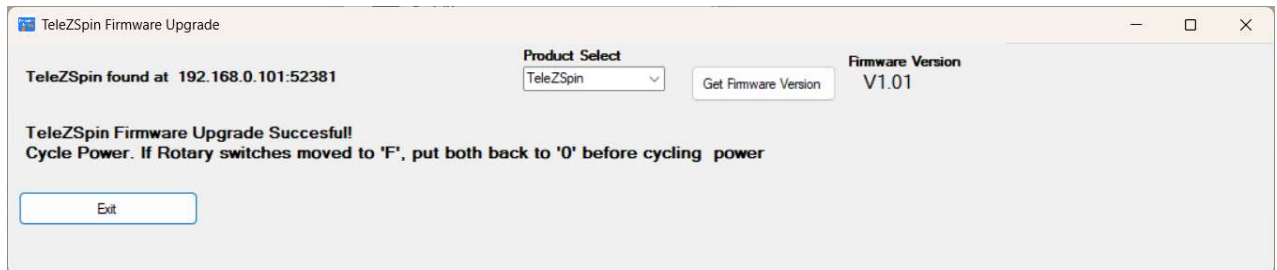

14. Click “Exit”, Cycle the power on the PTZMoverIP. To verify, relaunch the Firmware Upgrade app and check that the firmware version is correct